

# STANDARD REGENAIR BLOWER

## OPERATION & MAINTENANCE MANUAL



Model R1 Shown



Model R6P350A Shown

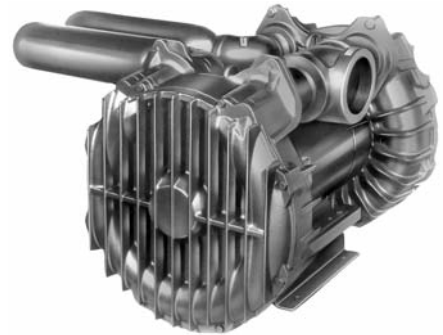

Model R7P Shown

Thank you for purchasing this Gast product. It is manufactured to the highest standards using quality materials. Please follow all recommended maintenance, operational and safety instructions and you will receive years of trouble free service.



### WARNING



**PLEASE READ THIS MANUAL COMPLETELY BEFORE INSTALLING AND USING THIS PRODUCT. SAVE THIS MANUAL FOR FUTURE REFERENCE AND KEEP IN THE VICINITY OF THE PRODUCT.**

#### General information

##### This manual does not apply to:

- SDR Series blowers without motors
- Blowers powered with Explosion Proof Motors

##### Product Use Criteria:

- Pump only clean, dry air.
- Operate at -20°F - 104°F (-29°C - 40°C).
- Protect unit from dirt & moisture.
- Do not pump flammable or explosive gases or use in an atmosphere that contains such gases.
- Protect all surrounding items from exhaust air. This exhaust air can become very hot.
- Corrosive gases and particulate material will damage unit. Water vapor, oil-based contaminants or other liquids must be filtered out.
- The blower must be installed with the properly sized inlet and inline filters, gauges and relief valves to protect the product from dirt and over-heating.
- Consult your Gast Distributor/Representative before using at high altitudes.



A Unit of **IMX** Corporation

ISO 9001 & 14001 CERTIFIED

[www.gastmfg.com](http://www.gastmfg.com)

**Your safety and the safety of others  
is extremely important.**

We have provided many important safety messages in this manual and on your product. Always read and obey all safety messages.



This is the safety alert symbol. This symbol alerts you to hazards that can kill or hurt you and others. The safety alert symbol and the words "DANGER" and "WARNING" will precede all safety messages. These words mean:

** DANGER**

You will be killed or seriously injured if you don't follow instructions.

** WARNING**

You can be killed or seriously injured if you don't follow instructions.

All safety messages will identify the hazard, tell you how to reduce the chance of injury, and tell you what can happen if the safety instructions are not followed.

**INSTALLATION**

** WARNING**



**Electrical Shock Hazard**

**Disconnect electrical power at the circuit breaker or fuse box before installing this product.**

**Install this product where it will not come into contact with water or other liquids.**

**Install this product where it will be weather protected.**

**Electrically ground this product.**

**Failure to follow these instructions can result in death, fire or electrical shock.**

**Correct installation is your responsibility.** Make sure you have the proper installation conditions and that installation clearances do not block air flow.

**Blocking air flow over the product in any way can cause the product to overheat.**

**The blower must be installed with the properly sized inlet filter, gauge and relief valve to protect the product from dirt and over-heating.**

**Mounting**

The single impeller blower should be oriented with the shaft in a horizontal position, unless the model's product features state otherwise. The dual impeller models must be mounted with the shaft in a horizontal position.

Mounting the product to a stable, rigid operating surface and using shock mounts will reduce noise and vibration.

**Rotation**

From the motor side of the blower, check that the blower is rotating clockwise. (The motor side is marked with an arrow on most models.) Proper rotation can also be checked by the air flow at the IN and OUT ports. On blowers powered by a 3-phase motor, incorrectly connecting any two power lines can reverse direction.

**Plumbing**

**Remove any foreign material (burrs, chips, welding drops, slag, pipe cuttings, excess sealant, sand or lime) from plumbing.**

Check motor mounting and rotation before connecting to plumbing. Inlet and outlet ports are not designed to support plumbing.

Remove plugs from the IN and OUT ports. Use a small amount of pipe thread lubricant when connecting plumbing to protect the aluminum blower threads. Connect with pipe and fittings that are the same size or larger than the product's threaded ports. When installing two blowers in parallel, use plumbing that is two whole pipe sizes larger in diameter than that of the blower. Be sure to connect the intake and exhaust plumbing to the correct inlet and outlet ports.

Plumbing to remove the hot discharge air of larger blowers may be required to help maintain proper room ambient temperature. Use a relief valve to discharge excess air into the atmosphere. If the blower will be operated at 125mbar (50" H<sub>2</sub>O) or higher, metal pipe is required for hot exhaust air.

**Accessories**

Install two vacuum gauges, one before and one after filter, to monitor restriction through filters. As filters become clogged, performance efficiency will be reduced. Filters should be checked periodically and replaced when necessary. See page 7 for installation.

Install a relief valve to avoid changes in pressure or vacuum that can cause overloading of large blowers. Install an intake filter with a relief valve to prevent foreign material from entering blower if blower is used in a vacuum application in a dirty environment. In applications where there is high humidity or liquids being used in the process, install a moisture separator.

See Recommended Accessories on pages 7-9 or consult your Gast Distributor/Representative for additional filter and accessories recommendations. Do Not install check valves that close with a strong spring. The recommended check valves (page 7) provide minimal pressure drop, positive sealing and are resistant to the high discharge temperatures of large blowers.

**Motor Installation**

**It is your responsibility to contact a qualified electrician and assure that the electrical installation is adequate and in conformance with all national and local codes and ordinances.**

Select fuses, motor protective switches or thermal protective switches to provide protection. Fuses act as short circuit protection for the motor, not as protection against overload. Incoming line fuses must be able to withstand the motor's starting current. Motor starters with thermal magnetic overload or circuit breakers protect motor from overload or reduced voltage conditions. Motors without automatic restart require thermal protection or magnetic over-current cutout to prevent motor overloading from one phase in a 3-phase circuit, high starting frequency or jammed blower.

The power required will rise as differential pressure increases. The wiring diagram attached to the product or on page 6 of this manual provides required electrical information. Large motors have two diagrams, one for 50Hz wiring specifications and the other for 60Hz wiring specifications. Check that the power source is correct to properly operate the dual-voltage motor. If additional information is required, please consult your Gast Distributor/Representative.

### Electrical Connection

**! WARNING**



Electrical Shock Hazard

**This product must be properly grounded. Do not modify the plug provided. If it will not fit the outlet, have the proper outlet installed by a qualified electrician.**

**If repair or replacement of the cord or plug is necessary, do not connect the grounding wire to either flat blade terminal. The wire with insulation that is green or green with yellow stripes is the grounding wire.**

**Check the condition of the power supply wiring. Do not permanently connect this product to wiring that is not in good condition or is inadequate for the requirements of this product.**

**Failure to follow these instructions can result in death, fire or electrical shock.**

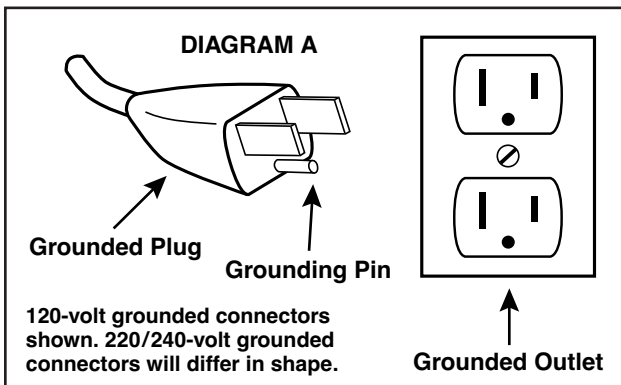

#### Model with a power supply cord:

This product must be grounded. For either 120-volt or 220/240-volt circuits connect power supply cord grounding plug to a matching grounded outlet. **Do not use an adapter.** (See DIAGRAM A)

In the event of an electrical short circuit, grounding reduces the risk of electric shock by providing an escape wire for the electric current. This product may be equipped with a power supply cord having a grounding wire with an appropriate grounding plug. The plug must be plugged into an outlet that is properly installed and grounded in accordance with all local codes and ordinances.

**Check with a qualified electrician or serviceman if the grounding instructions are not completely understood, or if you are not sure whether the product is properly grounded. Do not modify the plug provided. If it will not fit the outlet, have the proper outlet installed by a qualified electrician.**

#### Model that is permanently wired:

This product must be connected to a grounded, metallic, permanent wiring system, or an equipment grounding terminal or lead on the product.

Power supply wiring must conform to all required safety codes and be installed by a qualified person. Check that supply voltage agrees with that listed on product nameplate.

#### Extension cords:

Use only a 3-wire extension cord that has a 3-blade grounding plug. Connect extension cord plug to a matching 3-slot receptacle. **Do not use an adapter.** Make sure your extension cord is in good condition. Check that the gage wire of the extension cord is the correct size wire to carry the current this product will draw.

An undersized cord is a potential fire hazard, and will cause a drop in line voltage resulting in loss of power causing the product to overheat. The following table indicates the correct size cord for length required and the ampere rating listed on the product nameplate. **If in doubt, use the next heavier gage cord. The smaller the gage number, the heavier the wire gage.**

Minimum gage for extension cords											
Amps	Volts		Length of cord in feet								
	120v	240v	25	50	100	150	200	250	300	400	500
0-2	18	18	18	16	16	14	14	12	12	10	10
2-3	18	18	16	14	14	12	12	10	10	8	8
3-4	18	18	16	14	12	12	10	10	8	8	8
4-5	18	16	14	12	10	10	8	8	8	8	8
5-6	18	16	12	10	10	8	6	6	6	6	6
6-8	18	14	10	8	8	6	6	4	4	4	4
8-10	16	12	10	8	8	6	6	4	4	4	4
10-12	16	12	10	8	6	6	4	4	4	2	2
12-14	16	12	10	8	6	6	4	4	4	2	2
14-16	14	12	8	8	6	4	4	2	2	2	2
16-18	14	12	8	6	6	4	4	2	2	2	2
18-20	14	12	8	6	6	4	4	2	2	2	2

## OPERATION

### **WARNING**

#### **Injury Hazard**

Install proper safety guards as needed to prevent any close contact with blower suction area.

Keep fingers and objects away from openings and rotating parts.

Product surfaces become very hot during operation, allow product surfaces to cool before handling.

Air stream from product may contain solid or liquid material that can result in eye or skin damage, wear proper eye protection.

Wear hearing protection. Sound level from some models may exceed 85 dBA.

Failure to follow these instructions can result in burns, eye injury or other serious injury.

It is your responsibility to operate this product at recommended pressures or vacuum duties and room ambient temperatures. Do not operate R4P or larger size blowers without air flowing through the blower. Do not throttle discharge or suction pipe to reduce capacity. Throttle will increase differential pressure causing increasing power absorption and working temperatures.

#### **Start Up**

Operate blower for an hour and then check:

1. **Ambient temperature** – Check room and discharge air temperatures. Increased room temperatures may require stronger ventilation especially for larger blowers. Exhaust air should not exceed 215°F (102°C) for all blowers less than 3.5 Hp. Exhaust air should not exceed 275°F (135°C) for all blowers above 3.5 Hp.
2. **Working pressure and vacuum values** – Adjust relief valve pressure or vacuum setting, if needed.
3. **Motor current** – Check that supply current matches recommended current rating on product nameplate.
4. **Electrical overload cutout** – Check that current matches rating on product nameplate.

If motor fails to start or slows down significantly under load, shut off and disconnect from power supply. Check that the voltage is correct for motor and that motor is turning in the proper direction.

#### **FOR BLOWERS WITH GREASE FITTINGS**

Hours of Service Per Year	Relubrication Intervals
5,000	3 years
Continual Normal Service	1 year
Seasonal Service (motor idle for 6 months or more)	1 year at beginning of season
Continuous-high ambients, dirty or moist applications	6 months

Check that all external accessories such as relief valves and gauges are not damaged before re-operating product.

## MAINTENANCE

### **WARNING**



#### **Electrical Shock Hazard**

Disconnect electrical power supply cord before performing maintenance on this product.

Some motors are thermally protected and will automatically re-start when protector resets.

If product is hard wired into system, disconnect electrical power at the circuit breaker or fuse box before performing maintenance on this product.

Failure to follow these instructions can result in death, fire or electrical shock.

If the product is supplied with an electric power chord, protect it from twisting, cuts and abrasion. When not in use, store in a clean dry place

### **WARNING**

#### **Injury Hazard**

Product surfaces become very hot during operation, allow product surfaces to cool before handling.

Air stream from product may contain solid or liquid material that can result in eye or skin damage, wear proper eye protection.

Failure to follow these instructions can result in burns, eye injury or other serious injury.

It is your responsibility to regularly inspect and make necessary repairs to this product in order to maintain proper operation. Make sure that pressure and vacuum is released from product before starting maintenance.

Check filter elements and noise absorbing foam used in mufflers and clean motor and blower after first 500 hours of operation. Replace filter elements and determine how frequently mufflers should be checked during future operation. This one procedure will help assure the product's performance and service life.

When there is an increase in the differential pressure across the inlet filter it is beginning to clog with dirt. Replace the cartridge when the filter will not come clean.

Small motor bearings (less than 5.5 Hp) never need to be greased. Larger motor bearings (greater than 5.5 Hp) have alemite grease fittings. Use a grease gun and apply one or two strokes of Exxon POLYREX® grease to the fittings to lubricate larger motor bearings.

## WARRANTY

Gast finished products, when properly installed and operated under normal conditions of use, are warranted by Gast to be free from defects in material and workmanship for a period of twelve (12) months from the date of purchase from Gast or an authorized Gast Representative or Distributor. In order to obtain performance under this warranty, the buyer must promptly (in no event later than thirty (30) days after discovery of the defect) give written notice of the defect to Gast Manufacturing Incorporated, PO Box 97, Benton Harbor Michigan USA 49023-0097 or an authorized Service Center (unless specifically agreed upon in writing signed by both parties or specified in writing as part of a Gast OEM Quotation). Buyer is responsible for freight charges both to and from Gast in all cases.

This warranty does not apply to electric motors, electrical controls, and gasoline engines not supplied by Gast. Gast's warranties also do not extend to any goods or parts which have been subjected to misuse, lack of maintenance, neglect, damage by accident or transit damage.

THIS EXPRESS WARRANTY EXCLUDES ALL OTHER WARRANTIES OR REPRESENTATIONS EXPRESSED OR IMPLIED BY ANY LITERATURE, DATA, OR PERSON. GAST'S MAXIMUM LIABILITY UNDER THIS EXCLUSIVE REMEDY SHALL NEVER EXCEED THE COST OF THE SUBJECT PRODUCT AND GAST RESERVES THE RIGHT, AT ITS SOLE DISCRETION, TO REFUND THE PURCHASE PRICE IN LIEU OF REPAIR OR REPLACEMENT.

GAST WILL NOT BE RESPONSIBLE OR LIABLE FOR INDIRECT OR CONSEQUENTIAL DAMAGES OF ANY KIND, however arising, including but not limited to those for use of any products, loss of time, inconvenience, lost profit, labor charges, or other incidental or consequential damages with respect to persons, business, or property, whether as a result of breach of warranty, negligence or otherwise. Notwithstanding any other provision of this warranty, BUYER'S REMEDY AGAINST GAST FOR GOODS SUPPLIED OR FOR NON-DELIVERED GOODS OR FAILURE TO FURNISH GOODS, WHETHER OR NOT BASED ON NEGLIGENCE, STRICT LIABILITY OR BREACH OF EXPRESS OR IMPLIED WARRANTY IS LIMITED SOLELY, AT GAST'S OPTION, TO REPLACEMENT OF OR CURE OF SUCH NONCONFORMING OR NON-DELIVERED GOODS OR RETURN OF THE PURCHASE PRICE FOR SUCH GOODS AND IN NO EVENT SHALL EXCEED THE PRICE OR CHARGE FOR SUCH GOODS. GAST EXPRESSLY DISCLAIMS ANY WARRANTY OF MERCHANTABILITY OR FITNESS FOR A PARTICULAR USE OR PURPOSE WITH RESPECT TO THE GOODS SOLD. THERE ARE NO WARRANTIES WHICH EXTEND BEYOND THE DESCRIPTIONS SET FORTH IN THIS WARRANTY, notwithstanding any knowledge of Gast regarding the use or uses intended to be made of goods, proposed changes or additions to goods, or any assistance or suggestions that may have been made by Gast personnel.

Unauthorized extensions of warranties by the customer shall remain the customer's responsibility.

CUSTOMER IS RESPONSIBLE FOR DETERMINING THE SUITABILITY OF GAST PRODUCTS FOR CUSTOMER'S USE OR RESALE, OR FOR INCORPORATING THEM INTO OBJECTS OR APPLICATIONS WHICH CUSTOMER DESIGNS, ASSEMBLES, CONSTRUCTS OR MANUFACTURES.

This warranty can be modified only by authorized Gast personnel by signing a specific, written description of any modifications.

## ELECTRICAL WIRING DIAGRAMS

<b>Models</b> R1102, R2103, R2105, R3105-1, R3105-12, R4110-2		<b>Model</b> R6150J-2
<b>Low Voltage Single Phase</b>	<b>High Voltage Single Phase</b>	<b>Low Voltage Single Phase</b>
<b>Blue</b> P1 ————— Line <b>Brown</b> P2 ————— <b>Black</b> 5 ————— Tie together <b>Orange</b> 3 ————— & Insulate <b>White</b> 2 ————— <b>Yellow</b> 4 ————— Tie together Line	P1 ————— Line P2 ————— Insulate 5 ————— 3 ————— Tie together 2 ————— & Insulate 4 ————— Line	T1 ————— Line T4 ————— Line  <b>Brown</b> ————— Thermostat <b>Wh/Yel</b> ————— Thermostat

<b>Models</b> R4P115, R5125-2, R6125-2	
<b>Low Voltage Single Phase</b>	<b>High Voltage Single Phase</b>
<b>Purple</b> ————— L1 <b>Brown</b> ————— Tie together <b>Orange</b> ————— & Insulate <b>Blue</b> ————— <b>White</b> ————— L2 <b>Red</b> —————	<b>Purple</b> ————— L1 <b>Brown</b> ————— Insulate <b>White</b> ————— Tie together <b>Orange</b> ————— & Insulate <b>Blue</b> ————— <b>Red</b> ————— L2

**Models**

R2303A, R3305A-1, R3305A-13, R4310A-2, R4P315A, R6350A-2, R6P350A, R6PP3110M, R6PS3110M, R7100A-3, R7P3180M, R7S3180M, R93150A

**Note:** Model R6P355A has two additional leads labeled “J” for an external thermal motor protection circuit.

**Connections for 3-Phase, 9 Leads**

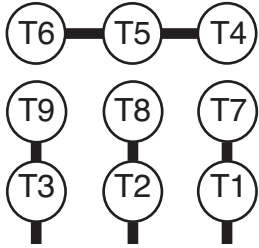

Line  
Low Voltage

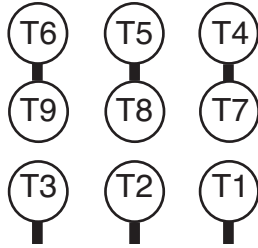

Line  
High Voltage

**Model R9P3300M, R93150A, R93150A-35**

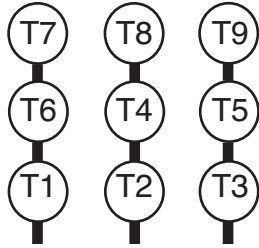

Line  
Low Voltage

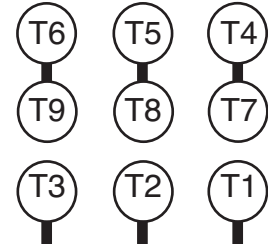

Line  
High Voltage

**Connections for 3-Phase, 12 Leads  
Models R6335A-2, R6P335A**

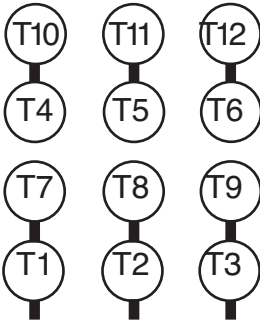

Line  
Low Voltage

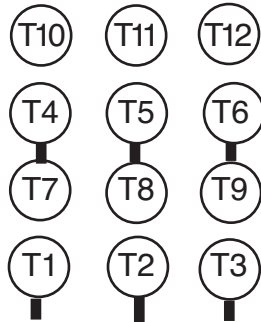

Line  
High Voltage

**Models R5325A-2, R6325A-2 (BEFORE 1-1-06)**

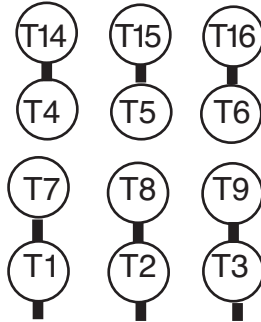

Line  
Low Voltage

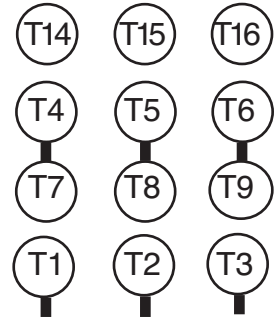

Line  
High Voltage

**Models R5325A-2, R6325A-2 (AFTER 1-1-06)**

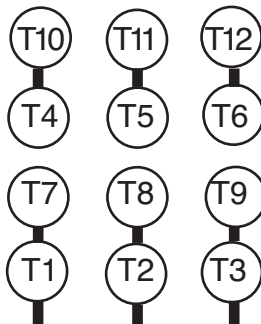

Line  
Low Voltage

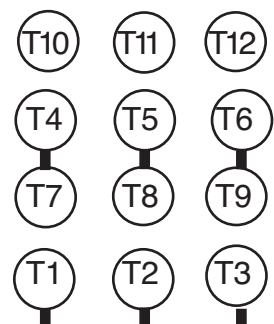

Line  
High Voltage

To reverse rotation on any 3-Phase motor, interchange any two external motor line connections to any two line leads.

## RECOMMENDED ACCESSORIES

The following diagrams are only suggested configurations for these accessories. These accessory configurations may vary depending upon a particular unit's application.

### VACUUM ACCESSORIES

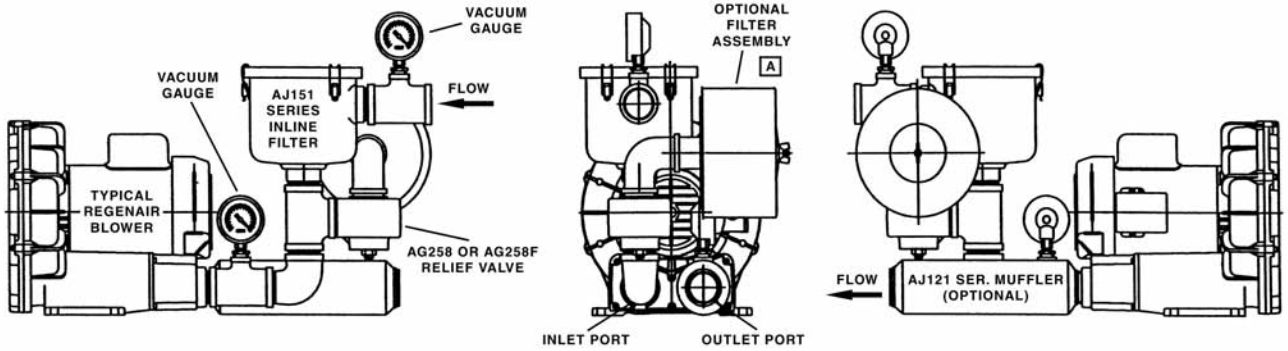

### PRESSURE ACCESSORIES

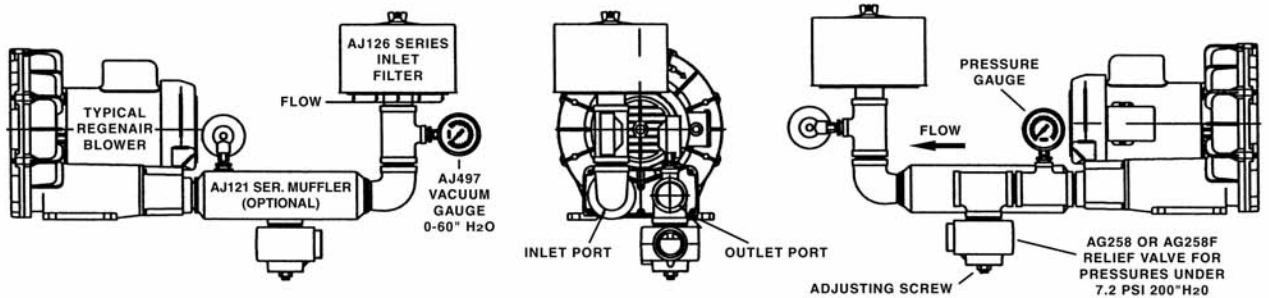

### MOISTURE SEPARATOR (FOR VACUUM)

This moisture separator removes liquids from the gas stream in a vacuum process. This helps protect the blower from corrosion and the build up of mineral deposits.

For Model Number	R3, R4, R5	R4, R4H, R4P, R5	R4H, R4M, R5, R6, R6P, R6PS,	R4M, R6, R6P, R6PP, R7, R7P, R7S, R9, R9S
Part Number	RMS160	RMS200	RMS300	RMS400
CFM capacity	160	200	300	400
Liquid capacity (gal.)	10	19	19	40
Diameter (A)	14.8"	19.7"	19.7"	24"
Dimension (B)	37.5"	35"	35"	44"
NPT outlet (C)	2"	2"	2.5"	3"
Inlet diameter (D)	2"	2"	2.5"	3"
Dimension (E)	7.5"	7.5"	7.5"	9.7"
Dimension (F)	26.6"	26.6"	26.6"	29"

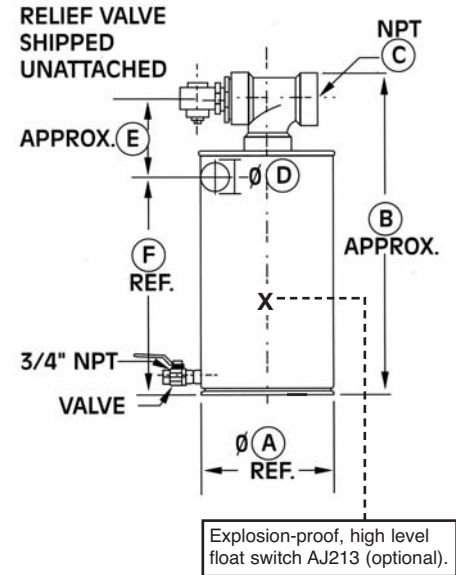

Maximum vacuum allowed: 22" Hg.

### HORIZONTAL SWING TYPE CHECK VALVE

This check valve prevents backwash of fluids from entering the blower and air back-streaming. The check valve can be mounted to discharge or inlet either vertically or horizontally. The check valve will open with 3" of water pressure or vacuum.

Model Number	R1, R2	R3	R4, R5, SDR4, SDR4, R4P	R6, R6P, SDR6P, SDR6, R6PS	R7, R7S
Part Number	AH326B	AH326C	AH326D	AH326F	AH326G
Dimension (A)	3.57"	4.19"	4.50"	5.25"	8.00"
Dimension (B)	2.32"	2.69"	2.94"	3.82"	5.07"
Dimension (C)	1.00" NPT	1.25" NPT	1.50" NPT	2.00" NPT	2.50" NPT

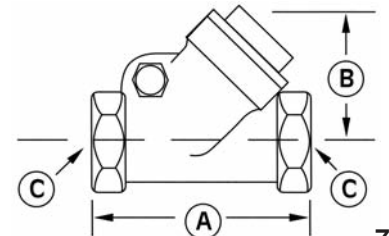

## RECOMMENDED ACCESSORIES



**PRESSURE – VACUUM GAUGE**

Pressure/Vacuum Gauges				
<b>AJ496</b>	2.50" Dia.	Pressure	1/4" NPT	0-60 in. H <sub>2</sub> O and 0-150 mbar
<b>AE133</b>	2.50" Dia.	Pressure	1/4" NPT	0-160 in. H <sub>2</sub> O and 0-400 mbar
<b>AE133A</b>	2.50" Dia.	Pressure	1/4" NPT	0-200 in. H <sub>2</sub> O
<b>AJ497</b>	2.50" Dia.	Vacuum	1/4" NPT	0-60 in. H <sub>2</sub> O and 0-150 mbar
<b>AE134</b>	2.50" Dia.	Vacuum	1/4" NPT	0-160 in. H <sub>2</sub> O and 0-400 mbar
<b>AE134F</b>	3.50" Dia.	Vacuum	1/4" NPT	0-15 in. HG

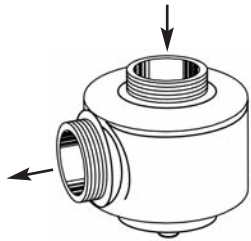

**PRESSURE – VACUUM RELIEF VALVE**

Pressure/Vacuum Relief Valves		
<b>AG258</b>	1.50" NPT	Adjustable 30-200 in. H <sub>2</sub> O; 200 cfm max
<b>AJ121D</b>		Silencer for AG258 Relief Valve
<b>AG258F</b>	2.50" NPT	Adjustable 25-200 in. H <sub>2</sub> O; 560 cfm max
<b>AJ121G</b>		Silencer for AG258F Relief Valve

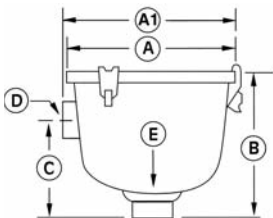

### INLINE FILTERS (FOR VACUUM)

The impeller of a blower passes very closely to the housing. It is recommended to have an inlet or in-line filter to ensure a trouble-free service life.

MPT = Male Pipe Thread  
FPT = Female Pipe Thread

Model Number	R1	R2	R3	R4	SDR4, R4P, R4H, R5	SDR5, SDR6, R6, R6P, R7M	R6PP, SDR6P, R6PS, R7, R7S	R7S, R9, R9P, R9S
<b>Part Number</b>	<b>AJ151A</b>	<b>AJ151B</b>	<b>AJ151C</b>	<b>AJ151D</b>	<b>AJ151E</b>	<b>AJ151G</b>	<b>AJ151H</b>	<b>AJ151M</b>
Dimension (A)	5.88"	7.38"	7.38"	7.38"	8.75"	8.75"	14.00"	18.50"
Dimension (A1)	–	–	–	–	–	–	16.25"	20.75"
Dimension (B)	4.50"	6.81"	6.81"	6.81"	10.25"	10.50"	27.13"	28.13"
Dimension (C)	2.75"	4.62"	4.62"	4.62"	5.00"	5.50"	18.50"	19.50"
Dimension (D)	1.00" FPT	1.00" FPT	1.25" FPT	1.50" FPT	2.00" FPT	2.50" FPT	3"MPT	5" MPT
Dimension (E)	1.00" FPT	1.00" FPT	1.25" FPT	1.50" FPT	2.00" FPT	2.50" FPT	3"MPT	5" MPT
Replacement Element	AJ135D	AJ135E	AJ135E	AJ135E	AJ135F	AJ135G	AJ135C	AJ135H
Micron	10	10	10	10	10	10	10	10

## RECOMMENDED ACCESSORIES

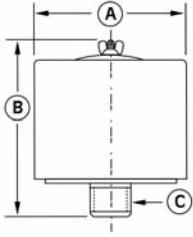

### INLET FILTERS (FOR PRESSURE)

All filters are heavy duty for high-particulate service. Inlet filters for Regenair blowers are drip-proof when mounted as shown..

MPT = Male Pipe Thread  
FPT = Female Pipe Thread

Model Number	R1, R2	R3	R4, R4H, R4P SDR4, R5	SDR5, R6, SDR6, R5P, R6PP, R6PS	SDR6P, R7, R7P, R7S	R9, R9P, R9S
Part Number	AJ126B	AJ126C	AJ126D	AJ126F	AJ126G	AJ126M
Dimension (A)	6.00"	6.00"	7.70"	10.62"	10.00"	16.00"
Dimension (B)	4.62"	7.12"	7.12"	4.81"	13.12"	14.62"
Dimension (C)	1.00" MPT	1.25" MPT	1.50" MPT	2.00" FPT	2.50" MPT	5" MPT
Replacement Element	AJ134B	AJ134C	AJ134E	AG340	AJ135A	AJ135H
Micron	10	10	10	10	10	10

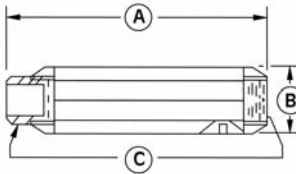

### MUFFLERS

Designed to reduce noise by up to 5 dbA and remove high-frequency sound associated with all blowers.

Model Number	R1, R2	R3	R4, SDR4, R4P, R5	R4H, R6, R6P, R6PS SDR6P, SDR6	R7, R7S	R6PP, R9 Exhaust	R7P Exhaust
Part Number	AJ121B	AJ121C	AJ121D	AJ121F	AJ121G	AJ121H	AJ121M
Dimension (A)	7.46"	7.94"	12.75"	17.05"	17.44"	20.30"	33.60"
Dimension (B)	2.38"	2.62"	3.25"	3.63"	4.25"	4.75"	6.00"
Dimension (C)	1.00" NPT	1.25" NPT	1.50" NPT	2.00" NPT	2.50" NPT	3" NPT	4"NPT

## PARTS & ORDERING INFORMATION

Please reference the exploded view on Page 11 for the following model and parts table.

REF#	ITEM	QTY	R1102 R1102C R1102K	R2103 R2303A	R2105	R2305B	R3105-1 R3305A-1 R3305B-1
1	COVER	1	AJ101A	AJ101B	AJ101B	AJ101B	AJ101C
2	LOCK NUT	1	BC187	BC187	BC181	BC181	BC181
3	IMPELLER	1	AJ102A	AJ102BQ	AJ102B	AJ102B	AJ102C
4	SQUARE KEY	1	AH212C	AH212	AB136A	AB136A	AB136A
5	SHIM SPACER	Δ	AE686-5	AE686-3	AJ109	AE686-3	AJ109
6	RETAINING RING	1	AJ145	AJ145	AJ149	AJ145	AJ149
7	HOUSING	1	AJ103A	AJ103BQ	AJ103B	AJ103B	AJ103C
8	-	-	-	-	-	-	-
9	-	-	-	-	-	-	-
10A	FOAM	Δ	AJ112A(4)	AJ112BQ(6)	AJ112BQ(6)	AJ112BQ(6)	AJ112C(4)
10B	FOAM	2	-	-	-	-	AJ112CQ
11	MUFFLER EXTENSION	1	AJ106A	AJ106BQ	AJ106BQ	AJ106BQ	AJ106CQ

Δ As required.

Parts listed are for stock models. For specific OEM models, please consult the factory. When corresponding or ordering parts, please give complete model and serial numbers.

## PARTS & ORDERING INFORMATION

Please reference the exploded view on the next page for the following model and parts tables.

REF#	ITEM	QTY	R3105-12 R3305A-13	R4110-2 R4310A-2 R4310B-1	R4P115 R4P315A†	R5125-2 R5325A-2 R5325B-1	R6125-2 R6150J-2 R6325A-2 R6335A-2 R6335B R6350A-2 R6350B-2	R6P335A R6P350A R6P350B	R6135J-10
1	COVER	1	AJ101C	AJ101D	AJ101L	AJ101EQ	AJ101FB	AJ101K	AJ101FB
2	LOCK NUT	1	BC181	BC181	BC181	AJ259	AJ259	AJ259	AJ259
3	IMPELLER	1	AJ102CA	AJ102D	AJ102L	AJ102E	AJ102FR	AJ102K	AJ102FR
4	SQUARE KEY	1	AB136A	AB136D	AB136D	AB136	AB136	AB136	AB136
5	SHIM SPACER	Δ	AJ109	AJ109	AJ109	AJ109	AJ109	AJ109	AJ260A
5 †	SHIM SPACER †	1	-	-	AJ109A †	-	-	-	-
6	RETAINING RING	1	AJ149	AJ149	AJ149	-	-	-	-
7	HOUSING	1	AJ103C	AJ103DR	AJ103L	AJ103EQ	AJ103FQ	AJ103K	AJ103FQ
8	MUFFLER BOX	1	-	-	-	-	-	AJ104K	-
9	SPRING	2	-	AJ113DR	AJ113DQ	AJ113DQ	AJ113FQ	AJ113FQ	AJ113FQ
9A	SCREEN	2	-	-	AJ123EQ	AJ123EQ	AJ123FB	-	AJ123FB
10A	FOAM	Δ	AJ112C(4)	AJ112DS(4)	AJ112ER(6)	AJ112ER(6)	AJ112FC(6)	AJ112K(8)	AJ112FC(6)
10B	FOAM	2	AJ112CQ	AJ112DR	-	-	-	-	-
11	MUFFLER EXTENSION	1	AJ106CQ	AJ106DQ	AJ106EQ	AJ106EQ	AJ106FR	-	AJ106FR

REF#	ITEM	QTY	R6P350A	R6P355A R6P350B	R6PP3110M*	R6PS3110M*	R7100A-3	R7100B-1
1	COVER	1	AJ101K	AJ101KA	AJ101KA(2)	AJ101KA(2)	AJ101G	AJ101G
2	LOCK NUT/BOLT	1	AJ259	BB750	BB750(2)	BB750(2)	BB750	BB750
3	IMPELLER	1	AJ102K	AJ102K	AJ102KA(2)	AJ102KA(2)	AJ102GZ	AJ102GA
4	SQUARE KEY	1	AB136	AB136	AB136(2)	AB136(2)	AC628	AC628
5	SHIM SPACER	Δ	AJ109	AJ169F	AJ169F	AJ169F	AJ110	AJ110
6	RETAINING RING	1	-	-	-	-	-	-
7	HOUSING	1	AJ103K	AJ103KA	AJ103KD(2)	AJ103KD(2)	AJ103GA	AJ103GA
8	MUFFLER BOX	1	AJ104K	AJ104K	-	-	AJ104GA	AJ104GA
8A	SCREEN	2	-	-	-	-	AJ998G	AJ998G
9	SPRING	2	AJ113FQ	AJ113FQ	-	-	-	-
10A	FOAM	Δ	AJ112K(8)	AJ112K (8)	-	-	AJ112GA(8)	AJ112GA(8)
10B	FOAM	2	-	-	-	-	-	-
11	MUFFLER EXTENSION	1	-	-	-	-	-	-
12 **	O-RING	2	-	-	AJ175	-	-	-
13	GASKET	4	-	-	AJ107F	AJ107F	-	-

REF#	ITEM	QTY	R7P3180M*	R7S3180M*	R9P3300M*	R9S3300M*	R93150A
1	COVER	1	AJ101G(2)	AJ101G(2)	AJ101M(2)	AJ101M(2)	AJ101M
2	LOCK NUT/BOLT	1	BB750(2)	BB750(2)	BB707(2)	BB707(2)	BB707
3	IMPELLER	1	AJ102GZ(2)	AJ102GZ(2)	AJ102M(2)	AJ102M(2)	AJ102M
4	SQUARE KEY	1	AC628(2)	AC628(2)	AE130A(2)	AE130A(2)	AE130A
5	SHIM SPACER	Δ	AJ110	AJ110	BJ110	BJ110	BJ110A
6	RETAINING RING	1	-	-	-	-	-
7	HOUSING	1	AJ103GA(2)	AJ103GA(2)	AJ103M(2)	AJ103M(2)	AJ103M
8	MUFFLER BOX	1	-	-	-	-	AJ104MP
8A	SCREEN	2	-	-	-	-	AJ998M
9	SPRING	2	-	-	-	-	-
10A	FOAM	Δ	-	-	-	-	AJ112M(10)
10B	FOAM	2	-	-	-	-	-
11	MUFFLER EXTENSION	1	-	-	-	-	-
12 **	O-RING	2	AJ175G	-	AJ175G	-	-

† R4P315A only.

\* Dual models.

\*\* Not shown.

Δ As required.

Parts listed are for stock models. For specific OEM models, please consult the factory.  
When corresponding or ordering parts, please give complete model and serial numbers.

**EXPLODED PRODUCT VIEW**

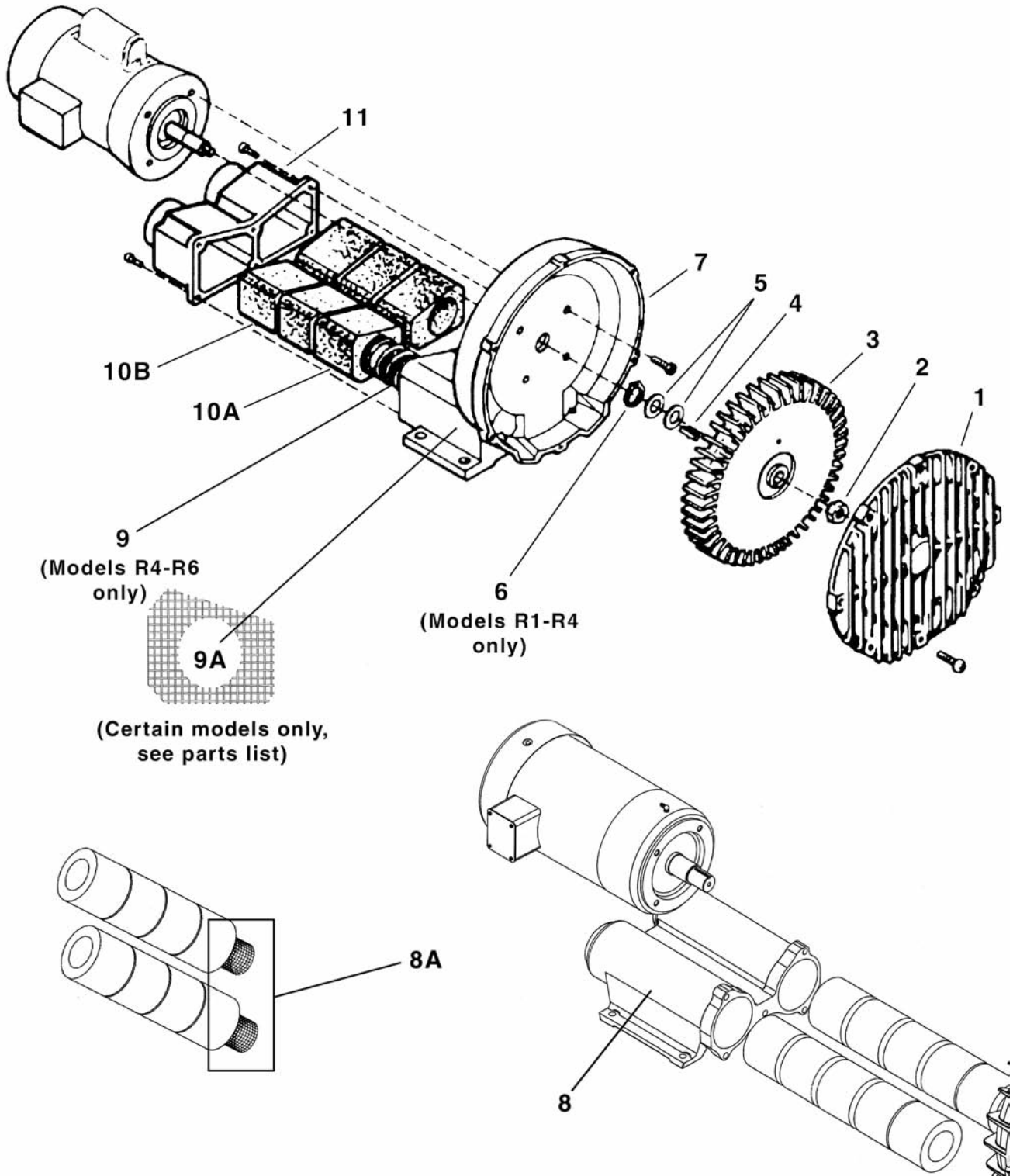

**TROUBLESHOOTING CHART**

<b>Problem</b>	<b>Reason</b>	<b>Remedy</b>
Increased sound.	Noise absorbing foam is damaged. Impeller rubbing inside.	Replace foam. Send unit to a Gast Authorized Service Facility.
Excessive vibration.	Damaged impeller. Motor and/or impeller are dirty.	Replace impeller. Clean motor and impeller periodically.
Ambient and exhaust temperature increases.	Motor and/or blower are dirty. Filters dirty.	Clean motor and blower periodically. Replace filters.
Decreased inlet air pressure	Inlet air filter is clogged.	Clean inlet filter. Replace cartridge.
Unit is very hot.	Wrong wiring. Low voltage. Inlet air filter is clogged. Motor and/or blower are dirty. Operating at too high a pressure or vacuum.	Check wiring. Supply proper voltage. Clean inlet filter. Replace cartridge. Clean motor and blower periodically. Install a relief valve and pressure or vacuum gauge.
Unusual sound.	Impeller is damaged or dirty. Bearing going bad.	Clean or replace impeller. Send unit to a Gast Authorized Service Facility.
Motor overload	Low voltage.	Check power source. Check wire size and wire connections.
Unit does not start.	Incorrect electrical connection or power source. Impeller is damaged.	Check wiring diagram, circuit fusing and circuit capacity. Clean or replace impeller. Install proper filtration.

**We have Gast Certified Service Centers throughout the world. For the most up-to-date listing, contact one of our sales offices below:**

**World Headquarters**

P.O. Box 97  
2300 S. Highway M139  
Benton Harbor, MI 49022  
Ph: 269/926-6171  
FAX: 269/925-8288  
www.gastmfg.com

**European Sales & Service Headquarters**

Gast Group Limited  
A Unit of IDEX Corporation  
Unit 11, The I O Centre  
Nach Road  
Redditch B98 7AS  
United Kingdom  
Tel: +44 (0) 1527 504040  
Fax: +44 (0) 1527 525262  
www.gastmfg.com  
www.jun-air.com

**Gast Hong Kong**

Unit 12, 21/F, Block B  
New Trade Plaza  
6, On Ping Street, Shatin  
N. T. Hong Kong  
Ph: (852) 2690 1008  
Fax: (852) 2690 1012  
www.gasthk.com



**ISO 9001 & 14001 CERTIFIED**

**www.gastmfg.com**